

Mounting Location of Antenna

This figure shows the separation distances from other antennas to avoid mutual interference.

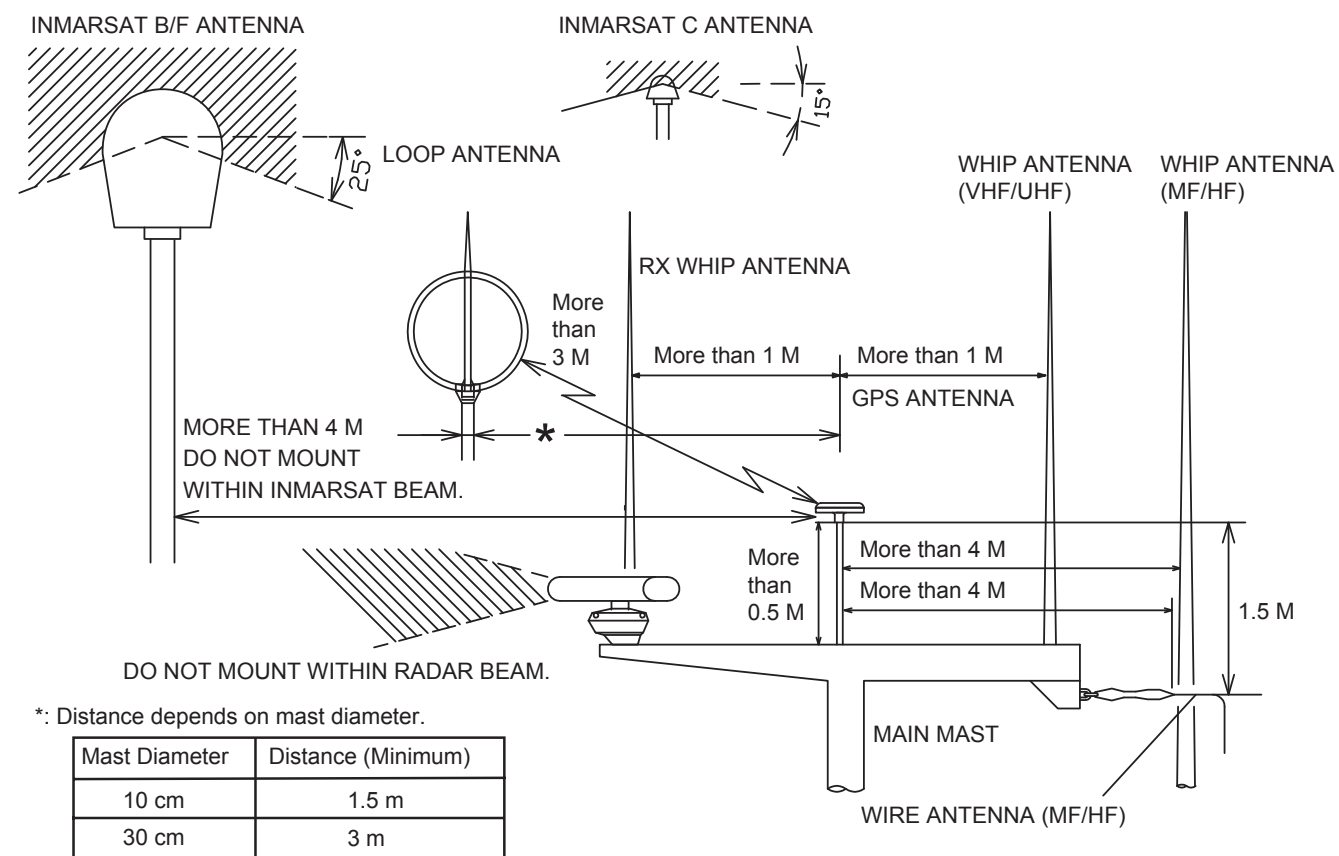

Mast Mounting

a) Use mast mounting kit CP20-01111.

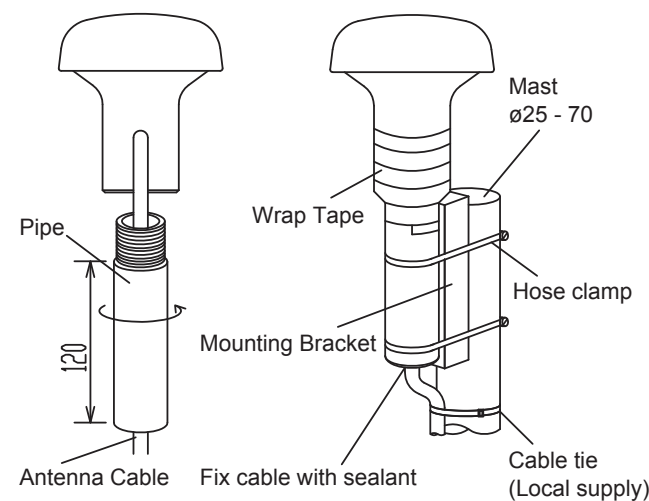

b) Use a pipe only.

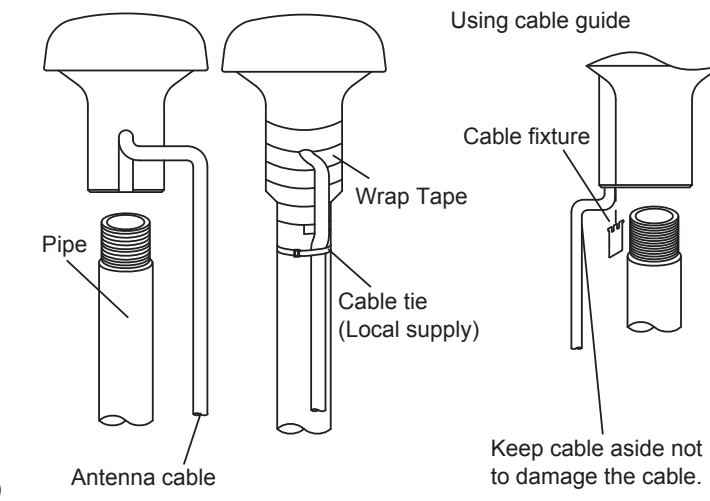

Downloading Operator's Manual

Please download the Operator's Manual from the following URL or quick response code to the right.
URL: <http://www.furuno.com/en/support/manuals/terms>



Pub. No. E42-01510-A1
(1609, TASU) GP-39



FURUNO GPS NAVIGATOR

English

Model

GP-39

User's Guide

This guide provides the basic operating and installation procedures for this equipment. For detailed information, see the Operator's Manual.

The brand and product names mentioned in this guide are trademarks, registered trademarks or service marks of their respective holders.

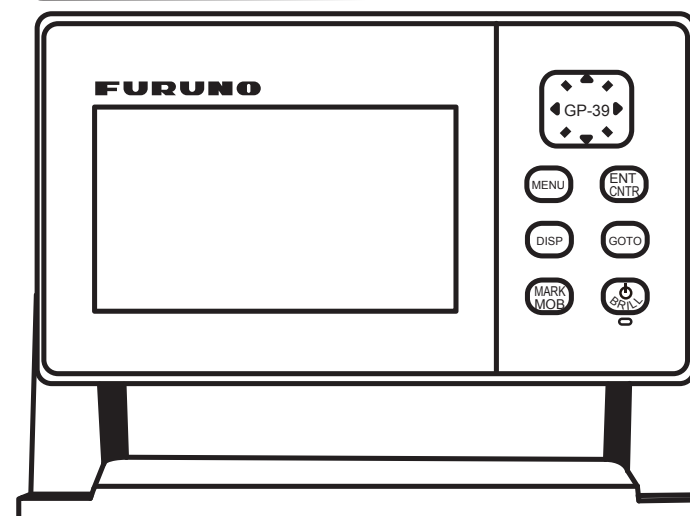

How to select a language

Only once after installation.

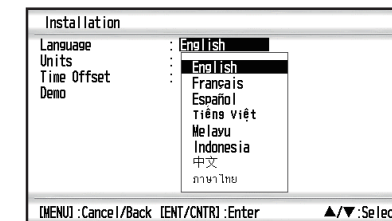

How to adjust brilliance of LCD and key

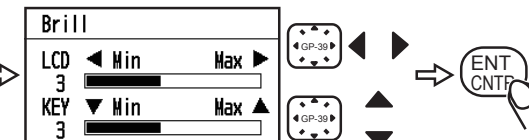

How to select a display

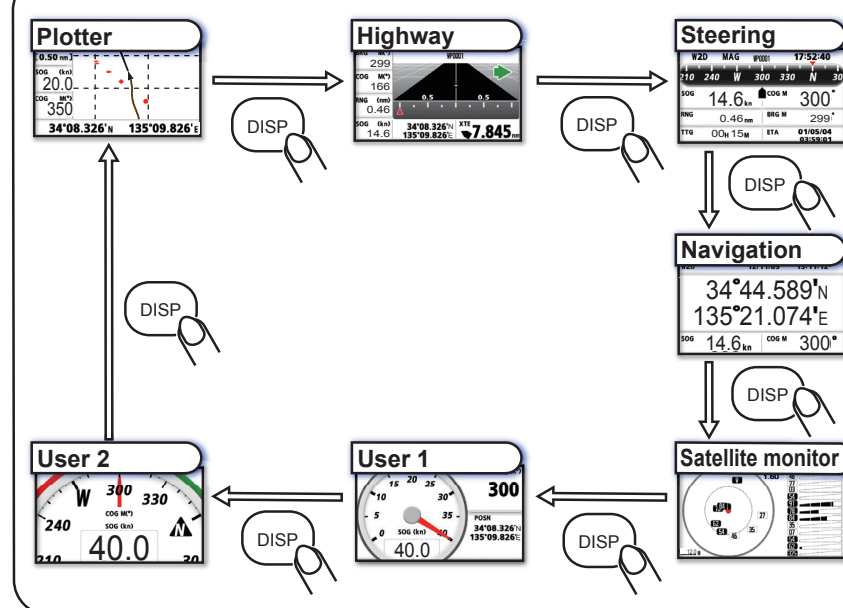

How to enter a waypoint

(Plotter display only)

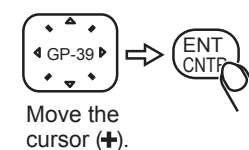

(Other than plotter display)

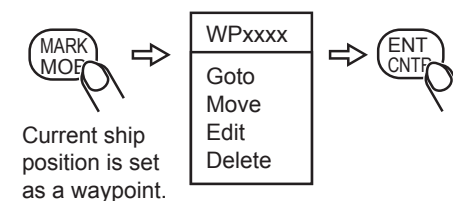

How to enter a MOB

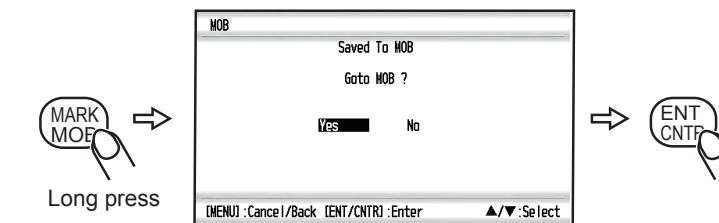

How to go to/Edit/Delete a waypoint

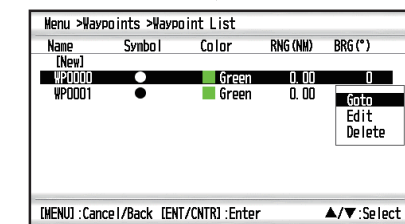
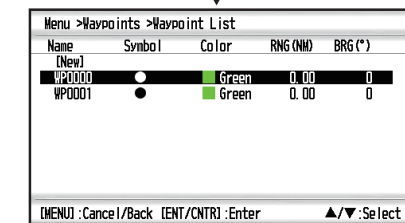
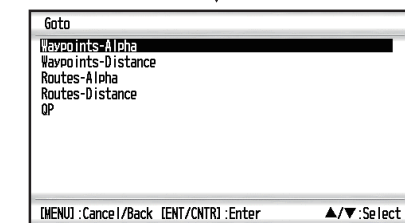

See Operator's Manual on how to create a route from a registered waypoint.

Troubleshooting

This section provides simple troubleshooting procedures which the user can follow to restore normal operation. If you cannot restore normal operation, do not attempt to check inside the unit. Any trouble should be referred to a qualified technician.

| Symptom | Remedy |
|---|--|
| You cannot turn on the power. | Check that power cable is firmly fastened. |
| | Check for damaged power cable and connector. |
| | Check battery for proper voltage output. |
| No picture appears. | Press the BRILL key several times to adjust the brilliance. |
| There is no response when a key is pressed. | Turn off and on the power. If no change, ask your dealer. |
| Position is not fixed within 90 seconds. | Check that antenna connector is firmly fastened. |
| | Check the number of satellites on Satellite Monitor display. If there are two or less, check for obstructions between antenna unit and satellites. |
| Position is wrong. | Check that the correct geodetic chart system is selected on the GPS Setting screen. |
| | Enter position offset on the GPS Setting screen. |
| Bearing is wrong. | Check [Magnetic Variation] on the Plotter Setup screen. |

Use of the proper fuse

Use of the wrong fuse can damage the equipment or cause fire.

The 1.5 A fuse (Type: FGMB 125V 1.5A PBF, Code No.: 000-157-464-10) in the fuse holder inside of the unit protects the unit from overcurrent and equipment fault. If you cannot turn on the power, check the fuse to see if it has blown. If the fuse has blown, find the reason before you replace the fuse. If the fuse blows again after the replacement, contact your dealer for advice.

SPECIFICATIONS

1 ANTENNA UNIT

- 1.1 Receiving channel GPS: 12 channels parallel, 12 satellites tracking SBAS: 2 channels
- 1.2 Rx frequency 1575.42 MHz \pm 1.023 MHz
- 1.3 Rx code GPS: C/A code, SBAS: L1 C/A
- 1.4 Position fixing system All in view, 8 state Kalman filter
- 1.5 Position accuracy GPS 10 m (95% of the time, HDOP \leq 4) WAAS 3 m (95% of the time, HDOP \leq 4)
- 1.6 Tracking velocity 1000 kn MSAS 7 m (95% of the time, HDOP \leq 4)
- 1.7 Position fixing time Warm start: 30 s approx., Cold start: 90 s approx., Hot start 1 s approx.
- 1.8 Position update interval 1 s

2 DISPLAY UNIT

- 2.1 Display system 4.2-inch Color LCD, 480 x 272 dots, 92.88 (W) x 52.632 (H) mm
- 2.2 Display mode Plotter, Highway, Steering, NAV data, Satellite monitor, User display
- 2.3 Brilliance 700 cd/m² nominal
- 2.4 Projection Mercator
- 2.5 Range scale Plotter: 0.02/0.05/0.1/0.2/0.5/1/2/5/10/20/40/80/160/320 NM Highway: 0.2/0.4/0.8/1/2/4/8/16 NM
- 2.6 Memory capacity Track: 3000 pts, Waypoint: 10,000 pts w/ comment 13 character
- 2.7 Storage capacity 100 routes w/ 30 waypoint each
- 2.8 Alarms Arrival and anchor watch, Cross track error, Ship' s speed, WAAS, Time, Trip

3 INTERFACE

- 3.1 Number of ports NMEA0183 V1.5/2.0/3.0: 1 port, current roop USB: 1 port, USB2.0
- 3.2 Data sentences Input: RTE, TLL
Output: AAM, APB, BOD, BWC, BWR, DTM, GGA, GLL, GSA, GSV, RMB, RMC, VTG, XTE, ZDA
- 3.3 Output proprietary sentences PFEC GPrst, GPrtc, GPwpl, GPxfr, SDmrk

4 POWER SUPPLY

- 4.1 Display unit 12-24 VDC: 0.7-0.3 A

5 ENVIRONMENTAL CONDITIONS

- 5.1 Ambient temperature Antenna unit -25°C to +70°C (storage: -30°C to +75°C)
Display unit -15°C to +55°C (storage: -30°C to +75°C)
- 5.2 Relative humidity 93% or less at +40°C
- 5.3 Degree of protection Antenna unit IP56 Display unit IP55
- 5.4 Vibration IEC 60945 Ed.4

6 UNIT COLOR

- 6.1 Antenna unit N9.5
- 6.2 Display unit N1.0

Interconnection with other equipment

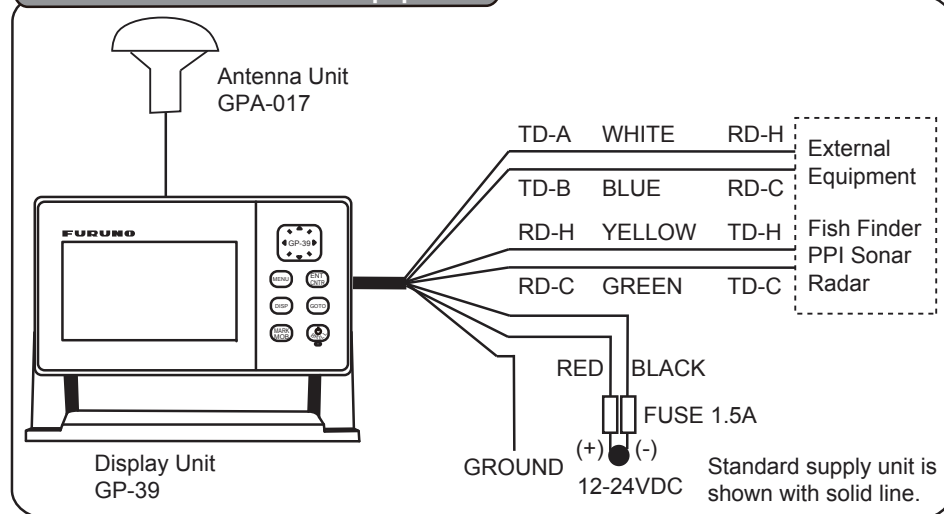

Note for treatment of LCD

Wipe the LCD carefully to prevent scratching, using tissue paper and a soft cloth. To remove dirt or salt, use a damp soft cloth, wiping slowly so as to dissolve the dirt or salt. Rinse the cloth regularly so the dirt or salt will not scratch the LCD. Do not use solvents such as thinner, acetone or benzene for cleaning. Also, do not use degreaser or antifog solution, as they can strip the coating from the LCD.

Outline Drawing

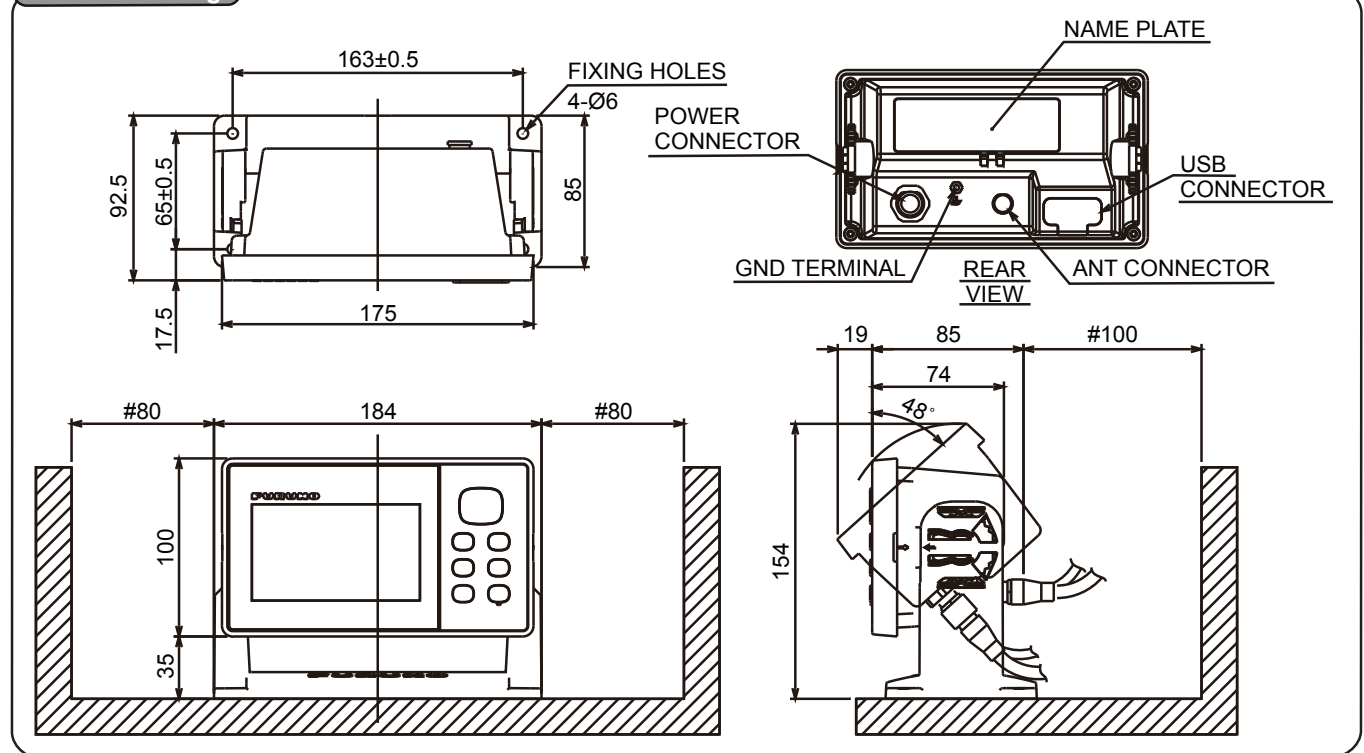

Attaching/Detaching the display unit to/from the hanger

To detach the receiver unit from the hanger, align the arrow marks on the unit and hanger. If the arrows are not aligned when you detach the unit, you may damage the unit or the hanger.

